

SMART SLIDE



140



42



V SUPER SOLUTION

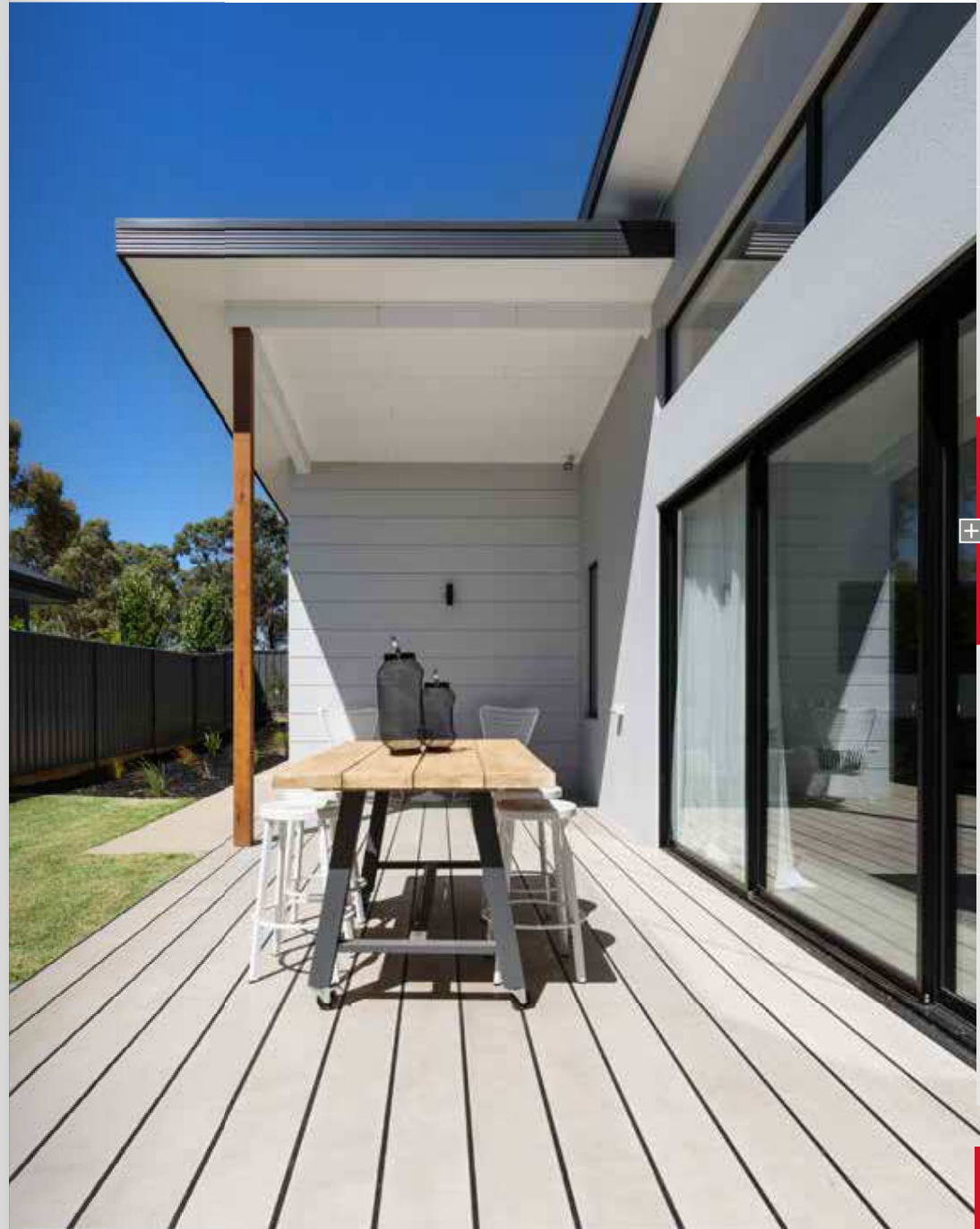

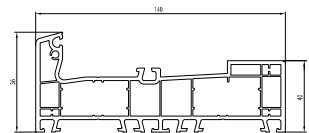

100091

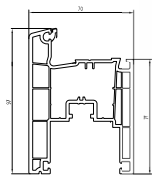

100094

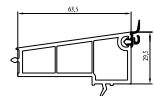

100291

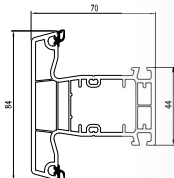

140x41

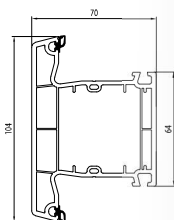

140x65

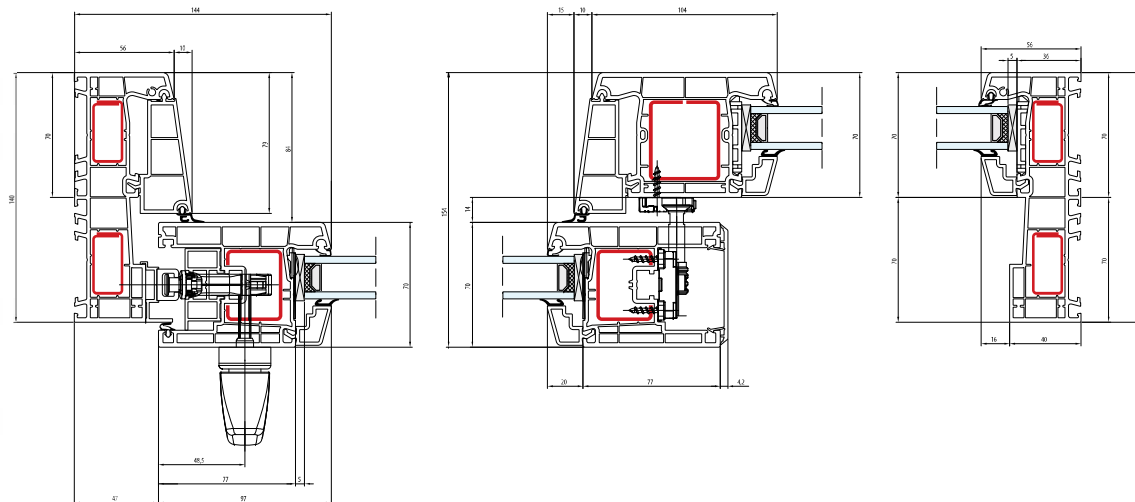

- Schemat A - Przekój poziomy - Rama: 56 mm - Skrzydło: 97 mm
- Schéma A - Coupe horizontale - Dormant: 56 mm - Vantail: 97 mm
- Schema A - Doorsnede horizontaal - Frame: 56 mm - Sajt: 97 mm
- Schema A - Wagerechtter Schnitt - Rahmens: 56 mm - Flügel: 97 mm
- Schema A - Sezione orizzontale - Telaio: 56 mm - Anta: 97 mm

1:2

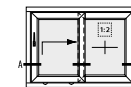

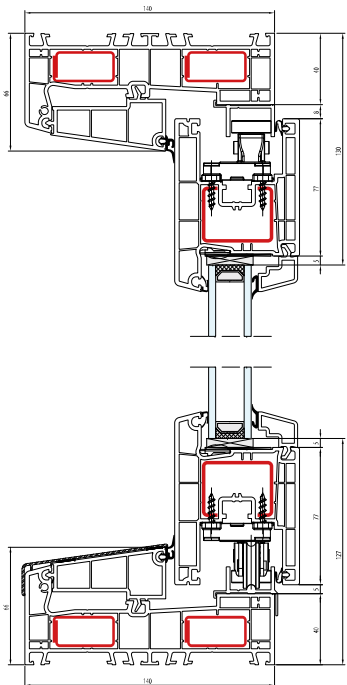

- Schemat A - Przekrój pionowy - Rama: 56 mm - Skrzydło: 97 mm
- Schéma A - Coupe verticale - Dormant: 56 mm - Vantail: 97 mm
- Schema A - Doorsneede verticaal - Frame: 56 mm - Sash: 97 mm
- Schema A - Senkrechter Schnitt - Rahmen: 56 mm - Flügel: 97 mm
- Schema A - Sezione verticale - Telaio: 56 mm - Anta: 97 mm

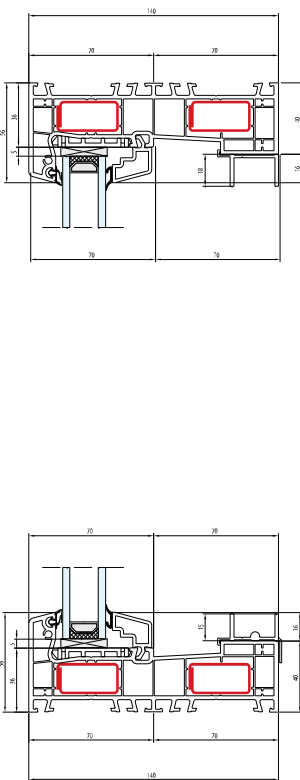
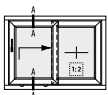

- Schemat A - Przekrój pionowy - Rama: 56 mm - Skrzydło: 97 mm
- Schéma A - Coupe verticale - Dormant: 56 mm - Vantail: 97 mm
- Schema A - Doorsneede verticaal - Frame: 56 mm - Sash: 97 mm
- Schema A - Senkrechter Schnitt - Rahmen: 56 mm - Flügel: 97 mm
- Schema A - Sezione verticale - Telaio: 56 mm - Anta: 97 mm

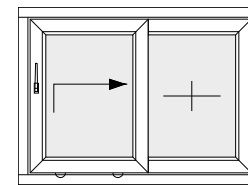
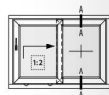

A

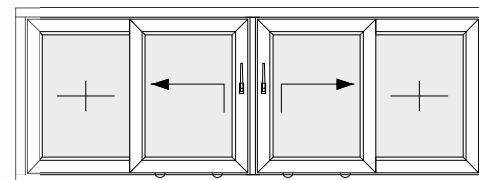

C

- Schemat
- Schéma
- Schema
- Schema
- Schema